



Manufacturers of High Temperature & High Vacuum Equipment

1017 Bransten Road | Phone (650) 593-1064  
 San Carlos, CA 94070 | Fax (650) 593-4458



## Specification Sheet

Equipment Model:  
 J-VAC-12-18x24  
 High Vacuum Furnace

Type	Vertical Bell, Turbo Pumped
Chamber	Stainless Steel Coldwall
Maximum Temperature	1250° C.
Maximum Ramp Rate	75° C per minute
Hot Zone	18" (45 cm) Dia. x 24" (60 cm) H. Nominal
Heating Element Type	1/8" Molybdenum Wire, Electric Resistive
Frame Dimensions	74" (137 cm) W. x 34" (86 cm) D. x 120" (305 cm) H.
Power Requirements	480V 3 Ph. 60A 60 Hz - 240V 3 Ph. 120A 60 Hz. 380/400/415V 3 Ph. 60A 50 Hz.
Gas Requirements	VENT: 30 - 50 psig, regulated, clean dry Nitrogen PROCESS: 30 - 50 psig Argon or Helium, high purity
Turbo	ISO 250, 1000L/S, (38,000 rpm) Ceramic Bearings
Thermocouple	Type "C" Tungsten-Rhenium, Control and Overtemp
Compressed Air	80 PSI regulated Clean/Dry

### Expected Vacuum, standard configuration:

- Process vacuum at temperature 10<sup>-6</sup> torr [clean and empty chamber]
- Vacuum at ambient, 10<sup>-7</sup> torr.

### Cooling Requirements

- 5 Ton (60,000 BTU)
- 35 psig, at 6 gallons per minute.
- Note: Maximum backpressure is 15 psig.

### Standard Features:

- 1000 L/S Agilent Turbomolecular Pump
- High Vacuum isolation valve
- Easy to use Touchscreen Controllers
- Mass Flow Controller for Process Gas
- Ethernet connectivity with webserver and FTP
- Survey Thermocouple with Cascade Control
- Equipment on casters to roll into place
- Sight glass for calibration melts
- **Fully automatic** - One button push starts the run. Automatically it will rough pump and cross over to high vac, ramp to temperature and soak, cooldown, and let up to ATM.

### Options:

- Additional Survey Thermocouples
- Hydrogen / Inert Gas Operation
- Auxiliary High-Vacuum Ports
- High-Temperature Furniture



Manufacturers of High Temperature & High Vacuum Equipment

1017 Bransten Road | Phone (650) 593-1064  
San Carlos, CA 94070 | Fax (650) 593-4458

## Equipment Description

### Model J-VAC-1200

#### **TURBO-PUMPED, HIGH VACUUM FURNACE**

*For Automatic, Continuous Operation to 1250° C*

**Work Zone: 18"(450mm) Dia. x 24"(600mm) H, 1250° C**



#### **General machine overview:**

Camco furnaces are controlled atmosphere, water-cooled "batch" style furnaces that are meant to process a single load at a time. Once parts are loaded, the user chooses the appropriate recipe for processing the load, and the entire profile is performed automatically. The controller determines when the furnace chamber can be opened safely at the end of the run based on physical and software safety interlocks, relay logic, pressure, and temperature checks. The outside of the water-cooled chamber is safe to touch at any process temperature, and also helps remove heat at the end of each run. Common uses for the machine are high-temperature brazing, sintering, heat treating, and clean firing.

Camco furnaces come standard with an advanced setpoint PID controller with many options, and this manual is a guide to the basic functions that users must understand before operating the machine. The controller was developed by Camco Furnace, for Camco furnaces, and is not recommended or supported for use with any other type of furnace or machine.

This machine is designed to heat to **1250°C**. It is intended to operate normally in a high-vacuum atmosphere. An included Argon connection with a Mass Flow Controller (MFC) can be used for creating a partial pressure environment, as well as a full positive pressure Argon atmosphere for processing or cooling parts. This furnace is also approved for use with forming gas (H5N) and helium in place of the argon. A nitrogen hookup is used with a throttled vent valve for venting the chamber to atmosphere.

#### **Base Unit**

The base unit measures 55"(140cm) wide by 34"(86cm) deep by 40"(100cm) high. Its' substantial frame is constructed of heavy wall square steel tubing. With the chamber fully raised the hoist and chamber assembly is 120"(305cm) high. Service access is readily gained through a hinged steel door and the removable front, side, and rear panels. The plate steel floor within the base unit supports the heating transformer and closes the bottom. Also contained within the base unit is the SCR unit, power components, and other electronics. At the lower right are the atmosphere control module, gas plumbing and cooling water plumbing. The high vacuum turbo pump, roughing pump and manifolds are also located within the right side of the cabinet. In addition, the base frame supports the instrument console and the water-cooled chamber bottom end at a convenient operator height for loading of product. A fan at the rear of the base unit draws cooling air through a replaceable filter element to cool the power control unit and transformer. A handy feature is the inclusion of recessed heavy-duty casters. The unit is easily rolled into place, and the leveling feet are lowered to immobilize and level the equipment. With the removal of the hoist assembly and the top cover, this unit can fit through a standard door. The finish used on this, and all CAMCO equipment is baked powder coating, chosen for its' durability. The stainless steel top skin reduces the possibility of load contamination.

## Hoist Assembly

The chamber/furnace assembly is mounted to the arm of the motor driven hoist assembly by which it may be raised to provide access to the work area. The mounting allows the chamber to lift with respect to the hoist. The hoist itself is driven with a heavy-duty ball screw assembly, and cannot inadvertently lower on the removal of power. Its speed is approximately eighteen inches per minute, a rate that is slow enough to minimize jarring, while not being inconvenient. Limit switches control the extremes of travel. Large bearing areas assure hoist rigidity and long life, and further assist in providing close registration of the chamber to the chamber bottom assembly upon closing.

## Temperature Control

Multi-stage programmed Ramp & Soak Temperature control (closed-loop PID) and vacuum sequencing are achieved through the use of an IDEC PLC and HMI Touchscreen controller. The software was developed 100% in-house and is fully optimized for Camco Furnaces.

The controller receives its' input signal from a thermocouple located close to the heating element. A second thermocouple is used to monitor the load. A third flexible inonel sheathed type "K" thermocouple can be attached directly to the workload for processes below 1250°C. All inputs are logged by the controller for real-time monitoring as well as observing historical data.

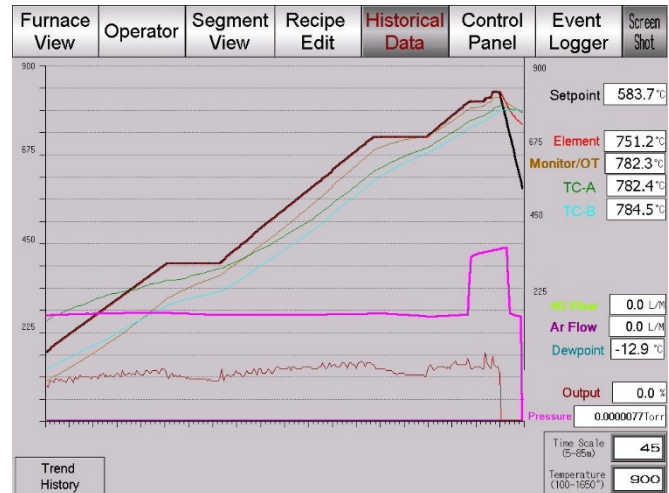

The furnace controller may also use any thermocouple input, or combination of installed thermocouples, to use for the heating loop or for guaranteed soak calculation. This is sometimes called "Cascade" controls and can be changed at any time based on recipes written by the user.

## Operation

The work is loaded onto the 18" diameter hearth plate and the chamber is lowered via the hoist switch and a button will close the clamps. One of the selectable, user-programmed thermal profiles is chosen, and the "RUN" key is pressed to begin. This run command will start the recipe, and automatically it will rough the chamber, cross over to the high vacuum pump, ramp to temperature and soak, cool-down and vent with nitrogen, helium, or argon. Upon completion of the cooldown portion of the program, the clamps may be opened, the hoist then raised, and the parts unloaded.

## Chamber/Furnace assembly

The stainless steel water-jacketed chamber bottom end is mounted on the base unit. It is sealed in operation to the chamber by a flange containing a viton "O" ring. The location of the seal is such that it is well cooled and optically baffled assuring long life. The chamber bottom includes work and survey thermocouple feed-throughs, gas admission and exhausts plumbing. It supports the Molybdenum hearth and bottom end stack of six shields via the lower support structure. The furnace chamber is located within the jacketed stainless steel chamber. It incorporates a Molybdenum heating element consisting of six sections each supported by high alumina insulators. This surrounds the eighteen-inch diameter by twenty-four-inch high work area. A series of four Molybdenum cylindrical heat shields and the top and bottom stack of four shields surround the elements. This assembly is supported from the inner wall of the chamber.

In addition, the chamber includes the insulated water-cooled power feedthroughs, control thermocouple, sightport, and required cylindrical heat shield support structure. Perforated stainless steel guards surround the heater power feedthroughs and provide electrical protection to the operator. The chamber assembly is supported by the hoist arm, and is located by pilot guides to assure accurate registration to the chamber bottom assembly when the furnace is lowered. Pneumatic clamping assures a positive seal to the bottom chamber assembly.

## Power Control

Power is proportionally controlled through use of a digitally controlled SCR three phase power module. This unit is phase angle fired control, and includes three phase current limiting made necessary by the strongly positive resistivity coefficient of the heating element. In the event of a power outage at higher temperature, the load temperature would drop to a level where a hard application of heat might thermally shock damage the parts. In this event, an abort relay will trip, and the program will resume and time out under the process atmosphere without the application of heat. Impedance match of the heating elements to the incoming power is accomplished through a conservatively rated 40 KVA transformer driven by this power module.

## Vacuum Pumps and Gauges

This machine achieves a high vacuum with two-stage pumping of a mechanical backing “foreline pump” and a turbo-molecular pump. Starting and stopping the turbo pump is handled automatically and must pass several pressure, leak, and interlock checks before operating. All high vacuum pumping is isolated from the chamber with a large-bore gate valve.

A “Roughing” bypass valve exists for pumping around the gate valve and turbo pump. This allows a large amount of pumping to be performed without disturbing the high vacuum components, allowing additional cleanliness and less wear and tear.

System pressures are read with four different types of gauges: A dual scale pressure transducer (Capacitance manometer and Pirani,  $1.0e-3$  to 1000 Torr), standard convection gauges (for general chamber and foreline low-pressure,  $1.0e-3$  to 1.0 torr), and a hot-filament ionization gauge which can accurately measure high vacuum to  $1.0e-9$  torr. The convection gauges are used for verifying safe conditions to start the turbo pump. The pressure transducer is a gas-agnostic gauge used for accurately measuring higher pressures closer to atmosphere, as well as partial-pressure environments using argon or helium that would otherwise disrupt convection gauges from reading properly.

## Partial Pressure Operation: $1e^{-4}$ to $1e^{-1}$ Torr

For certain brazing processes, it is advantageous (or even necessary) to suppress the high-vacuum levels during the actual braze melt. This is due to the vapor point of some alloys becoming very close to the melting point at pressures achievable in the furnace, and the braze alloy risks evaporating if there is even a slight overshoot on the temperature of the furnace reaches. **Please understand the vapor curve of all metals introduced into the furnace** to not accidentally volatilize any parts or braze alloy.

To mitigate this, the furnace allows the recipe to sweep a small amount of high purity noble gas, typically argon, while the turbo pump is still operating to maintain approximately  $1e^{-2}$  torr pressure level. This gas is carefully metered with a mass flow controller (MFC) and is highly repeatable. This effectively raises the vapor point of the braze alloy. This state causes some slight stress on the turbo and is only recommended to use during the actual braze melt portion of the recipe and to use a high vacuum for all other times to minimize wear and tear.

Partial pressure can also be performed at higher pressures (between 1 and 5 torr) with a “roughing” valve that will bypass the turbo entirely.

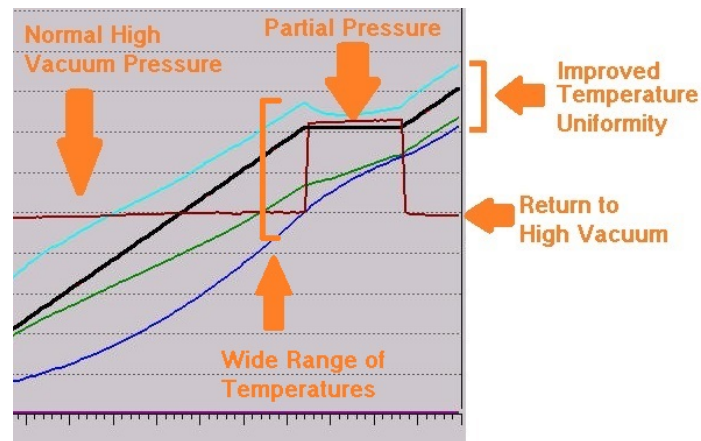

## Vacuum Ramp Delay

Logic based on the ion gauge and a set-point declared in the recipe can be used to toggle the recipe timer between RUN and HOLD to keep vacuum level below a programmed vacuum cap setpoint during periods of high gas load (vacuum/heat ramp delay). This feature can be programmed to be active, or non active, anytime throughout the run. The controller will keep track of how often this is triggered while used, and reports it to the event logger and in the run summary at the end of every cycle.

## Atmosphere Control Option

The model JVAC-1200 [18x24] can be ordered with combination hydrogen atmosphere control. Customer-supplied Hydrogen and Nitrogen gasses are admitted to the chamber through programmed valves and preset flow-meters. An interlock is included which provides for automatic Nitrogen purge in the event of loss of Hydrogen/Nitrogen or chamber pressure. Recipe-set Mass Flow Controllers operate the flow of gasses to achieve the appropriate operating atmosphere.

This option included many additional components and safety features but otherwise does not change the overall size of the machine or work zone. Please inquire for more information.

## Standard Safety Features

All Camco machines adhere to relevant standards outlined in the NFPA 86 Standard for Industrial Ovens and Furnaces, among others.

These numerous interlocking safety features include but are not limited to:

- Panel Interlocks remove high voltage when open
- Over-temperature Limit Abort
- Adjustable chamber “Safe Access Temperature” to protect operators
- High cabinet temperature
- Chamber exterior temperature
- Low coolant flow
- Low Process Gas pressure switches
- Vacuum cap delay, and various over-pressure abort setpoints
- All turbo pump operation and venting is completely automatic to prevent costly failures
- Many other hard-coded sequences minimize operator and programming errors.

## Documentation

Facilities information is supplied to assist in site preparation for installation. An operating manual is supplied with the equipment. Worksheets included in the manual provide a convenient form to depict the desired process for entry into the touchscreen controller. The worksheets also serve as a hard copy of the program. The unit is shipped with an example program stored in memory, depicted by the example worksheet. Wiring and plumbing schematics along with a published spare parts list are also included in the manual. Vendor-supplied manuals for the program controller, overtemp, SCR, vacuum pumps, and other small items are supplied in our documentation.

A recommended startup sequence and relatively simple operation of the furnace are well described and documented in the manual. Most customers can start up the machine without additional on-site support from Camco. However, commissioning and on-site training are always available, and costs can be included in furnace quotations if desired.

While the furnace is a complete, stand-alone unit as described, many applications suggest the inclusion of one or more of the options described in the enclosed data. Other, less commonly ordered options can also be provided. Please inquire for more information.

**Note:** The required process chiller is NOT included in any quotation prices. If your facility requires additional process cooling, Camco can recommend vendors and appropriate units if needed.



REV.	DATE	DESCRIPTION

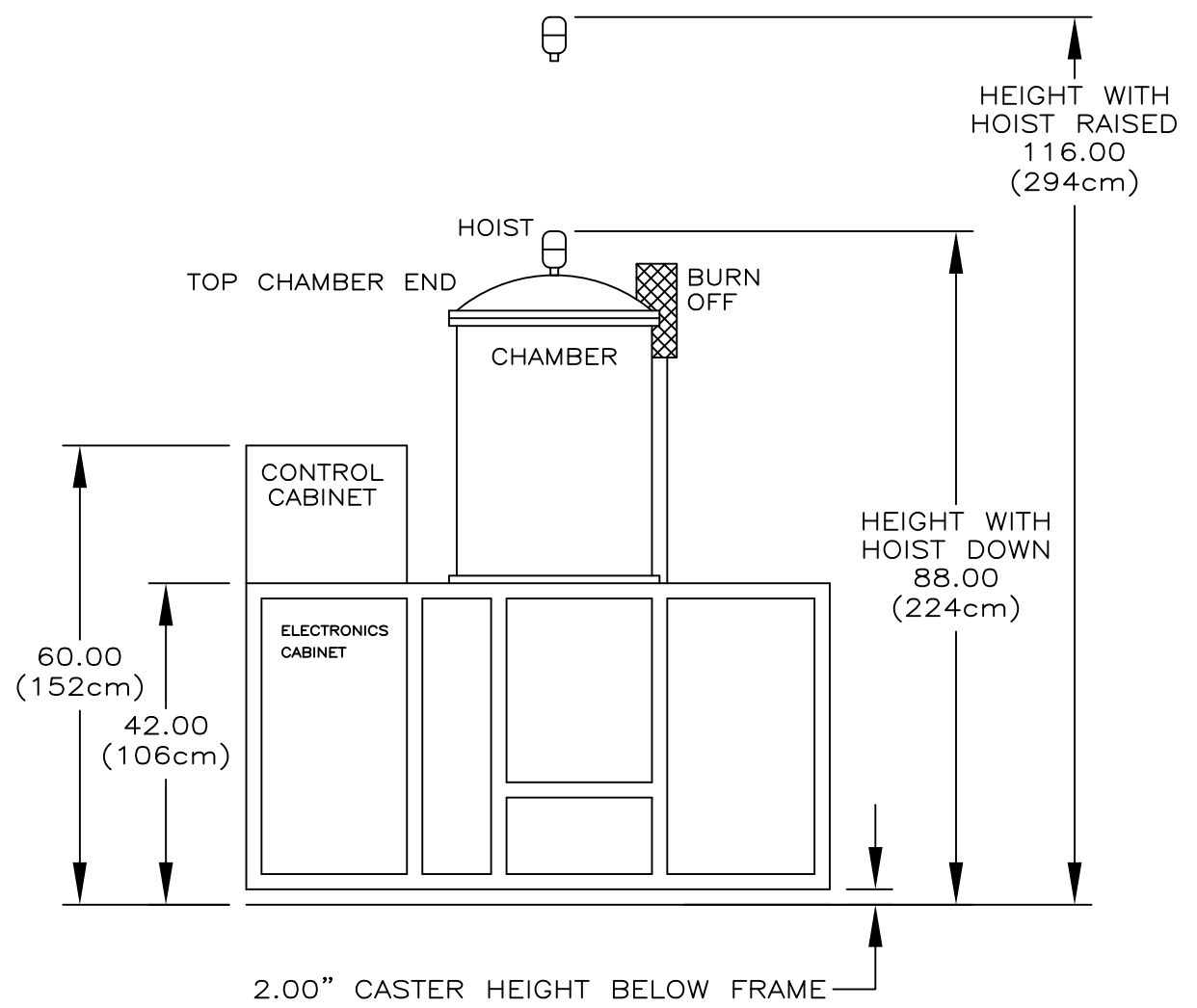
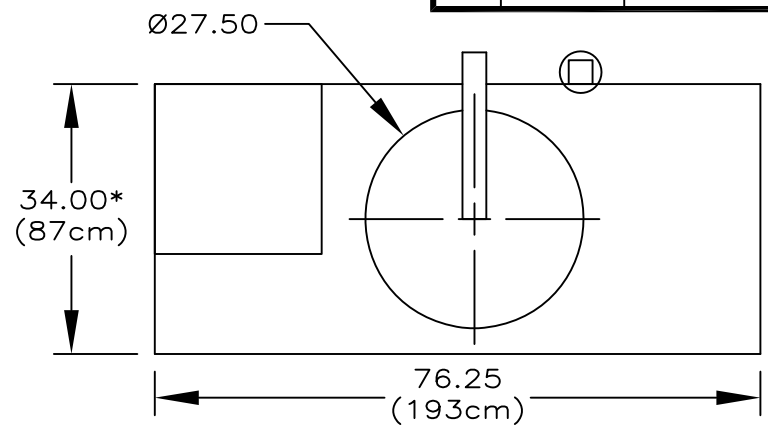

\*WITH HOIST REMOVED.

NOTE: WITH THE TOP END OF THE CHAMBER AND THE HOIST REMOVED, THE FURNACE WILL FIT THRU A 36" x 80" (92cm X 204cm) DOOR.

**NOTICE:** This document contains information which may be confidential and/or tradeseecret and/or proprietary to Concepts & Methods Co. Inc. and its' affiliates. This document is submitted to you in confidence and shall not be reproduced, disclosed to others, or used in manufacture without the express written permission of Concepts & Methods Co. Inc.

		TOL'S EXCPT AS NOTED	DRN.BY: TBARULICH	 <b>Concepts &amp; Methods Company, Inc.</b>
		fract. ±1/32	APP.BY:	
		.XX ±.010	DATE: 3-11-16	
		.XXX ±.005	MAT:	
J-VAC-18X24		.XXXX ±.0005	FINISH:	TITLE: J-VAC 18X24 FRAME DIM
USED ON TASK	FWO	ANGLES ±1/2'		DWG.NO: 89728
				SHEET 1 OF 1
				REV:

REV.	DATE	DESCRIPTION

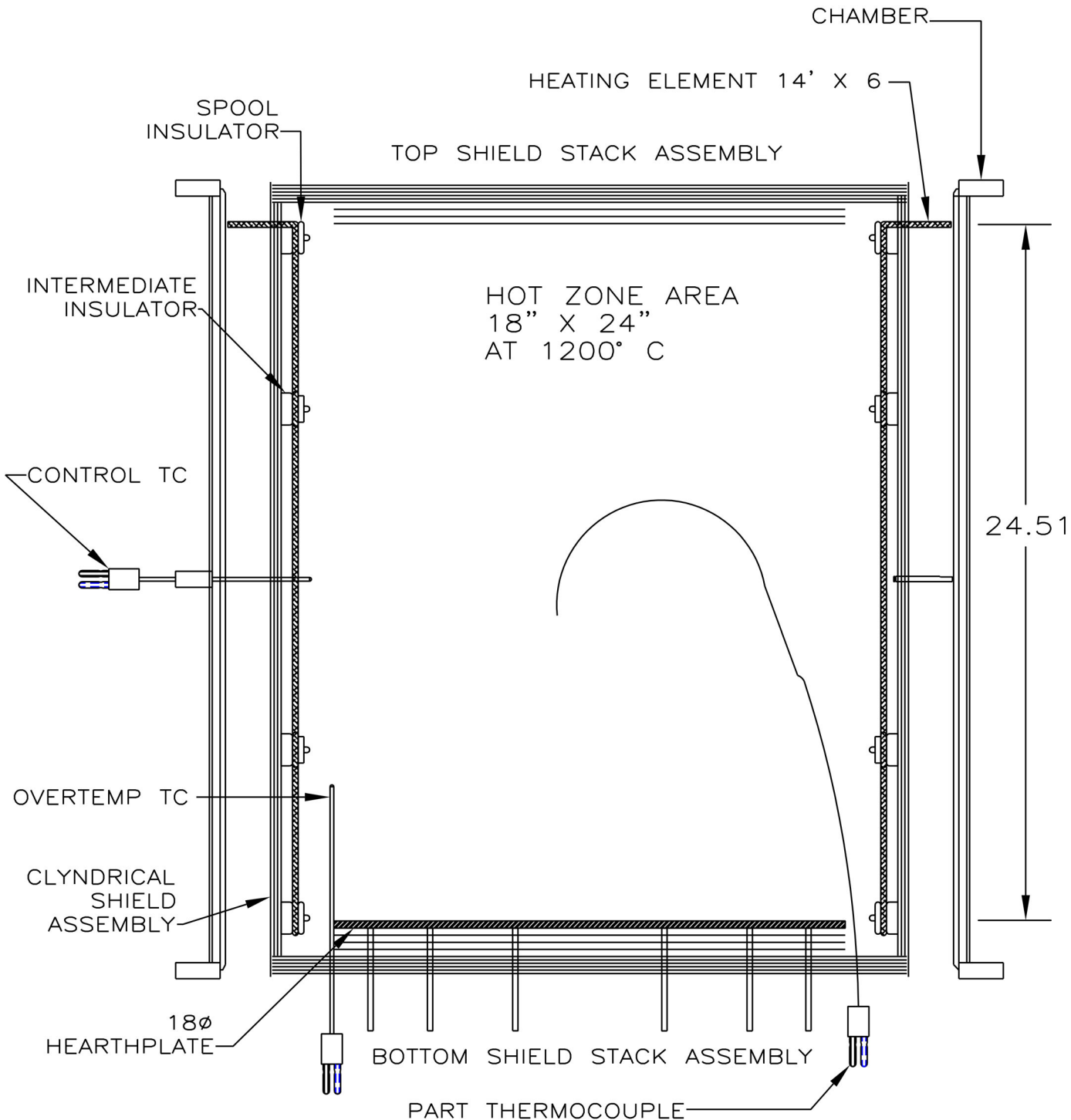

**NOTICE:** This document contains information which may be confidential and/or tradeseecret and/or proprietary to Concepts & Methods Co. Inc. and its' affiliates. This document is submitted to you in confidence and shall not be reproduced, disclosed to others, or used in manufacture without the express written permission of Concepts & Methods Co. Inc.

		TOL'S EXCPT AS NOTED	DRN.BY: T BARULICH	<b>CAMG</b> Concepts & Methods Company, Inc.	
		fract. ±1/32	APP.BY:		
		.XX ±.010	DATE: 3-26-05	TITLE: J-12 HOTZONE DIM	
J-12 FURNACE		.XXX ±.005	MAT: NOTED	DWG.NO: 88904	SHEET OF
USED ON TASK	FWO	.XXXX ±.0005	FINISH:		REV:
		ANGLES ±1/2'			

REV.	DATE	DESCRIPTION

UTILITIES: PREPARED AS SHOWN BY CUSTOMER.

- A: 3 PH DISCONNECT. – KNIFE SWITCH WITH FUSES  
 60A./LEG @ 480VAC 50/60Hz  
 120A./LEG @ 240VAC 50/60Hz  
 70A./LEG @ 400VAC 50Hz (REQUIRES NEUTRAL + GROUND)
- B: NITROGEN, 30–50 PSI AT A MAXIMUM FLOW OF 100 CFH      1/4" SWAGELOK
- C: ARGON, 30–50 PSI AT A MAXIMUM FLOW OF 50 CFH      1/4" SWAGELOK
- D: COMPRESSED AIR 100 PSI REGULATED      1/4" SWAGELOK
- F: COOLING WATER SUPPLY; 40 PSI MAX AT 8–10 GPM      3/4" FPT
- G: COOLING WATER RETURN; 25 PSI MAX      3/4" FPT
- H: PROCESS LINE PRESSURE REGULATORS SET AT 40 PSI.

MAX HEAT LOAD 60,000 BTU FOR CHILLER CALCULATION

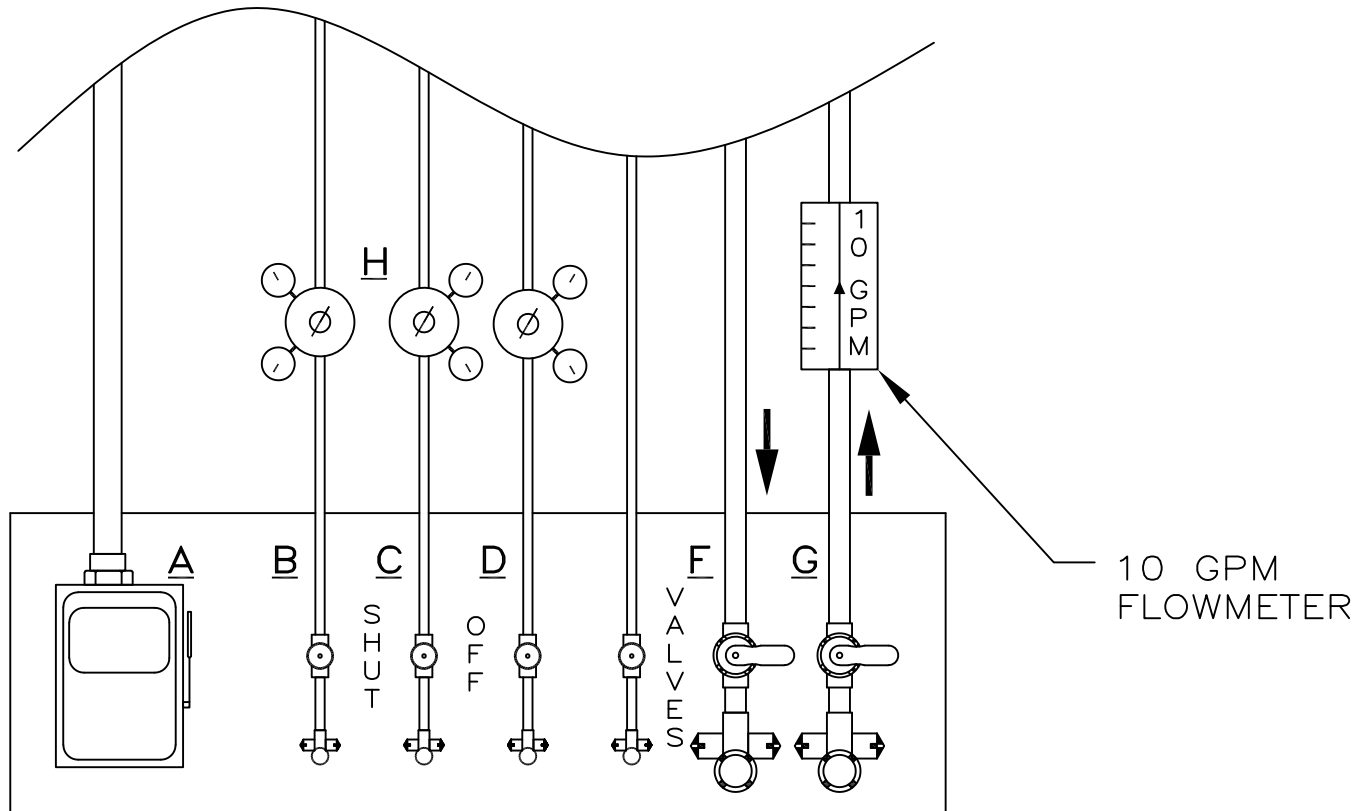

SUGGESTED UTILITY PANEL LAYOUT

**NOTICE:** This document contains information which may be confidential and/or tradeseecret and/or proprietary to Concepts & Methods Co. Inc. and its' affiliates. This document is submitted to you in confidence and shall not be reproduced, disclosed to others, or used in manufacture without the express written permission of Concepts & Methods Co. Inc.

		TOL'S EXCPT AS NOTED	DRN.BY: T BARULICH			
		fract. ±1/32	APP.BY:			
		.XX ±.010	DATE: 11-24-15	TITLE: J-VAC12 FACILITIES PREP. 50HZ		
		.XXX ±.005	MAT:	DWG.NO: 88189-5		
USED ON TASK	FWO	.XXXX ±.0005	FINISH:	SHEET 1 OF 5		REV: C
		ANGLES ±1/2'				