



Manufacturers of High Temperature & High Vacuum Equipment

1017 Bransten Road
San Carlos, CA 94070

Phone (650) 593-1064
Fax (650) 593-4458



Specification Sheet

Equipment Model:

B-VAC-2000

High Vacuum Furnace

Type	Turbo Pumped High Vacuum and Partial Pressure
Chamber	Stainless Steel Coldwall, Top loading
Maximum Temperature	2000° C.
Maximum Ramp Rate	75° C per minute
Hot Zone	8" (20 cm) Dia. x 12" (30 cm) H. Nominal
Heating Element Type	Tungsten Sheet or Mesh, Electric Resistive
Frame Dimensions	72" (183 cm) W. x 28" (72 cm) D. x 50" (127 cm) H.
Power Requirements	480V 3 Ph. 60A 60 Hz - 240V 3 Ph. 120A 60 Hz. 380/400/415V 3 Ph. 60A 50 Hz.
Gas Requirements	VENT: 30 - 50 psig, regulated, clean dry Nitrogen PROCESS: 30 - 50 psig Argon or Helium, high purity
High-Vacuum Turbo Pump	ISO 160, 850L/S, Agilent
Thermocouple	Type "C" Tungsten-Rhenium, Control and Overtemp
Compressed Air	80 PSI regulated Clean/Dry

Expected Vacuum, standard configuration:

- Process vacuum at temperature 10^{-6} torr [clean and empty chamber]
- Vacuum at ambient, 10^{-7} torr.

Cooling Requirements

- 5 Ton (60,000 BTU)
- 40 psig, at 5 gallons per minute.
- Note: Maximum backpressure is 15 psig.

Standard Features:

- 850 L/s Agilent Turbomolecular Pump
- 250 L/min Agilent Foreline Pump
- High Vacuum isolation valve
- Easy to use Touchscreen Controllers
- Mass Flow Controller for Process Gas
- Ethernet connectivity with webserver and FTP
- Survey Thermocouple with Cascade Control
- Equipment on casters to roll into place
- Sight glass for calibration melts
- Industrial Tower Light

Options:

- Additional Survey Thermocouples
- Hydrogen / Inert Gas Operation
- Auxiliary High-Vacuum Ports
- High-Temperature Furniture

- **Fully automatic** - One button push starts the run. Automatically it will rough pump and cross over to high vac, ramp to temperature and soak, cooldown, and let up to ambient pressure to open.



Manufacturers of High Temperature & High Vacuum Equipment

1017 Bransten Road | Phone (650) 593-1064
San Carlos, CA 94070 | Fax (650) 593-4458

Equipment Description

Model B-VAC-2000

TURBO-PUMPED, HIGH VACUUM FURNACE

For Automatic, Continuous Operation to 2000° C

Work Zone: 8" Dia. x 12" H



General machine overview:

Camco furnaces are controlled atmosphere, water-cooled "batch" style furnaces that are meant to process a single load at a time. Once parts are loaded, the user chooses the appropriate recipe for processing the load, and the entire profile is performed automatically. The controller determines when the furnace chamber can be opened safely at the end of the run based on physical and software safety interlocks, relay logic, pressure, and temperature checks. The outside of the water-cooled chamber is safe to touch at any process temperature, and also helps remove heat at the end of each run. Common uses for the machine are high-temperature brazing, sintering, heat treating, and clean firing.

Camco furnaces come standard with an advanced setpoint PID controller with many options, and this manual is a guide to the basic functions that users must understand before operating the machine. The controller was developed by Camco Furnace, for Camco furnaces, and is not recommended or supported for use with any other type of furnace or machine.

This machine is designed to heat to **2000°C**. It is intended to operate normally in a high-vacuum atmosphere. An included Argon connection with a Mass Flow Controller (MFC) can be used for creating a partial pressure environment, as well as a full positive pressure Argon atmosphere for processing or cooling parts. This furnace is also approved for use with forming gas (H5N) and helium in place of the argon. A nitrogen hookup is used with a throttled vent valve for venting the chamber and high vacuum components to atmosphere.

Base Unit

The base unit measures 63 inches wide by 29 inches deep and 50 inches tall. Its' substantial frame is constructed of heavy wall square steel tubing. Service access is readily gained through a hinged steel door and the removable front, side, and rear panels. The plate steel floor within the base unit supports the heating transformer and closes the bottom. Also contained within the base unit is the SCR unit, power components, and other electronics. At the lower right are the atmosphere control module, gas plumbing and cooling water plumbing. The high vacuum turbo pump, roughing pump and manifolds are also located within the right side of the cabinet. In addition, the base frame supports the instrument console and the water-cooled chamber bottom end at a convenient operator height for loading of product. A fan at the rear of the base unit draws cooling air through a replaceable filter element to cool the power control unit and transformer.

A handy feature is the inclusion of recessed heavy-duty casters. The unit is easily rolled into place, and the leveling feet are lowered to immobilize and level the equipment. This unit can fit through a standard door without any disassembly, easily being rolled into place with only two people. The finish used on this, and all CAMCo equipment is baked powder coating, chosen for its' durability. The stainless steel top skin reduces the possibility of load contamination.

Temperature Control

Multi-stage programmed Ramp & Soak Temperature control (closed-loop PID) and vacuum sequencing are achieved through the use of an IDEC PLC and HMI Touchscreen controller. The software was developed 100% in-house and is fully optimized for Camco Furnaces.

The controller receives its' input signal from a thermocouple located close to the heating element. A second thermocouple is used to monitor the load. A third flexible iniconel sheathed type "K" thermocouple can be attached directly to the workload for processes below 1250°C. All inputs are logged by the controller for real-time monitoring as well as observing historical data.

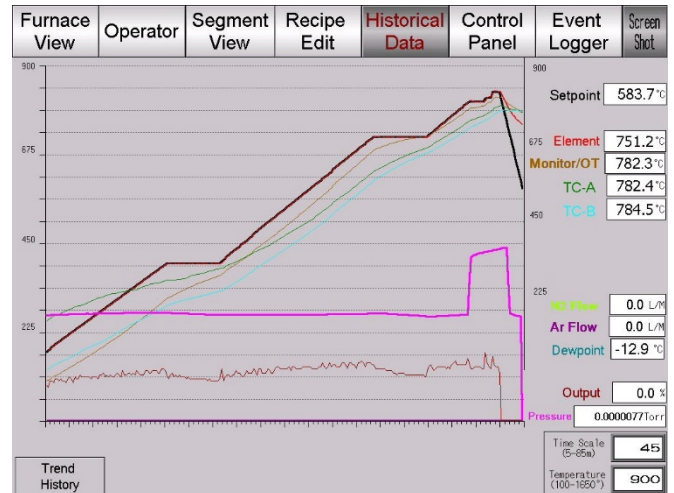

The furnace controller may also use any thermocouple input, or combination of installed thermocouples, to use for the heating loop or for guaranteed soak calculation. This is sometimes called "Cascade" controls and can be changed at any time based on recipes written by the user.

Operation

Work is loaded into the furnace, the top heat shield stack inserted, the cover closed and latched. One of nineteen selectable, user programmed thermal profiles is chosen, and the "start" key pressed. The high vacuum isolation valve opens and the chamber is rough pumped through the idle 160 mm, 850 L/PS turbo molecular pump. At a pre-defined vacuum setpoint (approx. $5.0 \cdot 10^{-1}$ Torr) a process relay turns the turbo pump on and the system is further pumped down to the 10^{-7} Torr pressure range within approximately 15 minutes. The furnace then performs the pre-programmed ramp & soak temperature profile, cool down, and vent to nitrogen. Upon completion of the cooldown portion of the program, the chamber is opened and unloaded.

Chamber/Furnace assembly

The stainless steel water-jacketed chamber bottom end is mounted on the base unit. It is sealed in operation to the chamber by a flange containing a viton "O" ring. The location of the seal is such that it is well cooled and optically baffled assuring long life. The chamber bottom includes work and survey thermocouple feed-throughs, gas admission and exhausts plumbing. It supports the Molybdenum hearth and bottom end stack of six shields via the lower support structure.

The furnace chamber is located within the jacketed stainless steel chamber. It incorporates a Molybdenum heating element consisting of six sections each supported by high alumina insulators. This surrounds the twelve-inch diameter by eighteen-inch high work area. A series of six Molybdenum cylindrical heat shields and the top and bottom stack of eight shields surround the elements. This assembly is supported from the inner wall of the chamber.

In addition, the chamber includes the insulated water-cooled power feedthroughs, control thermocouple, sightport, and required cylindrical heat shield support structure. All exposed surfaces of the chamber are safe to touch during the full normal operation of the furnace.

Power Control

Power is proportionally controlled through use of a digitally controlled SCR three phase power module. This unit is phase angle fired control, and includes three phase current limiting made necessary by the strongly positive resistivity coefficient of the heating element. In the event of a power outage at higher temperature, the load temperature would drop to a level where a hard application of heat might thermally shock damage the parts. In this event, an abort relay will trip, and the program will resume and time out under the process atmosphere without the application of heat. Impedance match of the heating elements to the incoming power is accomplished through a conservatively rated 40 KVA transformer driven by this power module.

Vacuum Pumps and Gauges

This machine achieves a high vacuum with two-stage pumping of a mechanical backing “foreline pump” and a turbo-molecular pump. Starting and stopping the turbo pump is handled automatically and must pass several pressure, leak, and interlock checks before operating. All high vacuum pumping is isolated from the chamber with a large-bore gate valve.

A “Roughing” bypass valve exists for pumping around the gate valve and turbo pump. This allows a large amount of pumping to be performed without disturbing the high vacuum components, allowing additional cleanliness and less wear and tear.

System pressures are read with four different types of gauges: A dual scale pressure transducer (Capacitance manometer and Pirani, $1.0e-3$ to 1000 Torr), standard convection gauges (for general chamber and foreline low-pressure, $1.0e-3$ to 1.0 torr), and a hot-filament ionization gauge which can accurately measure high vacuum to $1.0e-9$ torr. The convection gauges are used for verifying safe conditions to start the turbo pump. The pressure transducer is a gas-agnostic gauge used for accurately measuring higher pressures closer to atmosphere, as well as partial-pressure environments using argon or helium that would otherwise disrupt convection gauges from reading properly.

Partial Pressure Operation: $1e^{-4}$ to $1e^{-1}$ Torr

For certain brazing processes, it is advantageous (or even necessary) to suppress the high-vacuum levels during the actual braze melt. This is due to the vapor point of some alloys becoming very close to the melting point at pressures achievable in the furnace, and the braze alloy risks evaporating if there is even a slight overshoot on the temperature of the furnace reaches. **Please understand the vapor curve of all metals introduced into the furnace** to not accidentally volatilize any parts or braze alloy.

To mitigate this, the furnace allows the recipe to sweep a small amount of high purity noble gas, typically argon, while the turbo pump is still operating to maintain approximately $1e^{-2}$ torr pressure level. This gas is carefully metered with a mass flow controller (MFC) and is highly repeatable. This effectively raises the vapor point of the braze alloy. This state causes some slight stress on the turbo and is only recommended to use during the actual braze melt portion of the recipe and to use a high vacuum for all other times to minimize wear and tear.

Partial pressure can also be performed at higher pressures (between 1 and 5 torr) with a “roughing” valve that will bypass the turbo entirely.

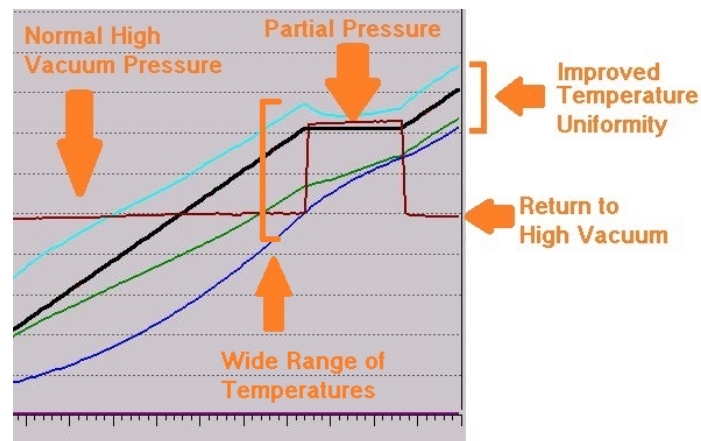

Vacuum Ramp Delay

Logic based on the ion gauge and a set-point declared in the recipe can be used to toggle the recipe timer between RUN and HOLD to keep vacuum level below a programmed vacuum cap setpoint during periods of high gas load (vacuum/heat ramp delay). This feature can be programmed to be active, or non active, anytime throughout the run. The controller will keep track of how often this is triggered while used, and reports it to the event logger and in the run summary at the end of every cycle.

Atmosphere Control Option

The model JVAC-1200 [18x24] can be ordered with combination hydrogen atmosphere control. Customer-supplied Hydrogen and Nitrogen gasses are admitted to the chamber through programmed valves and preset flow-meters. An interlock is included which provides for automatic Nitrogen purge in the event of loss of Hydrogen/Nitrogen or chamber pressure. Recipe-set Mass Flow Controllers operate the flow of gasses to achieve the appropriate operating atmosphere.

This option included many additional components and safety features but otherwise does not change the overall size of the machine or work zone. Please inquire for more information.

Standard Features

All Camco machines adhere to relevant standards outlined in the NFPA 86 Standard for Industrial Ovens and Furnaces, among others. Individual certification marks available upon request (CE, CSA, etc.)

These numerous interlocking safety features include but are not limited to:

- Panel Interlocks remove high voltage when open
- Over-temperature Limit Abort
- Adjustable chamber "Safe Access Temperature" to protect operators
- High cabinet temperature
- Chamber exterior temperature
- Low coolant flow
- Low Process Gas pressure switches
- Vacuum cap delay, and various over-pressure abort setpoints
- All turbo pump operation and venting is completely automatic to prevent costly failures
- Many other hard-coded sequences minimize operator and programming errors.

Other quality-of-life features include:

- Digital Mass Flow Controllers (MFCs) for all process gasses, for precise control and totalizing.
- Event and Operator logs for tracking all alarms, major events, and button presses
- User levels to prevent normal operators from modifying recipes or settings
- Screenshot any page at any time to capture and review anomalies
- Ethernet connectivity-
 - Webserver for real-time monitoring
 - FTP for easy retrieval of all data logs
- Front-panel USB for retrieving data logs, screenshots, and backing up recipes
- Free firmware updates when available - no subscription or extra costs

Documentation

Facilities information is supplied to assist in site preparation for installation. An operating manual is supplied with the equipment. Worksheets included in the manual provide a convenient form to depict the desired process for entry into the touchscreen controller. The worksheets also serve as a hard copy of the program. The unit is shipped with an example program stored in memory, depicted by the example worksheet. Wiring and plumbing schematics along with a published spare parts list are also included in the manual. Vendor-supplied manuals for the program controller, overtemp, SCR, vacuum pumps, and other small items are supplied in our documentation.

A recommended startup sequence and relatively simple operation of the furnace are well described and documented in the manual. Most customers can start up the machine without additional on-site support from Camco. However, commissioning and on-site training are always available, and costs can be included in furnace quotations if desired.

While the furnace is a complete, stand-alone unit as described, many applications suggest the inclusion of one or more of the options described in the enclosed data. Other, less commonly ordered options can also be provided. Please inquire for more information.

Note: The required process chiller is NOT included in any quotation prices. If your facility requires additional process cooling, Camco can recommend vendors and appropriate units if needed.



Graphical User Interface

Camco furnace is proud to announce that it has fully launched a standard line of touchscreen HMI/PLC controllers for all of its furnaces. These new components boast many advancements and quality-of-life upgrades compared to their previous controller schema. Most major features are now available standard and always without subscriptions or hidden costs. The intuitive user interface shows current furnace performance and the state of all components to take any guesswork out of the furnace operation.

(The following screens depict a standard combination high vacuum and hydrogen furnace - All furnaces are similar, but this may not be the exact interface for the information pack this is attached to)

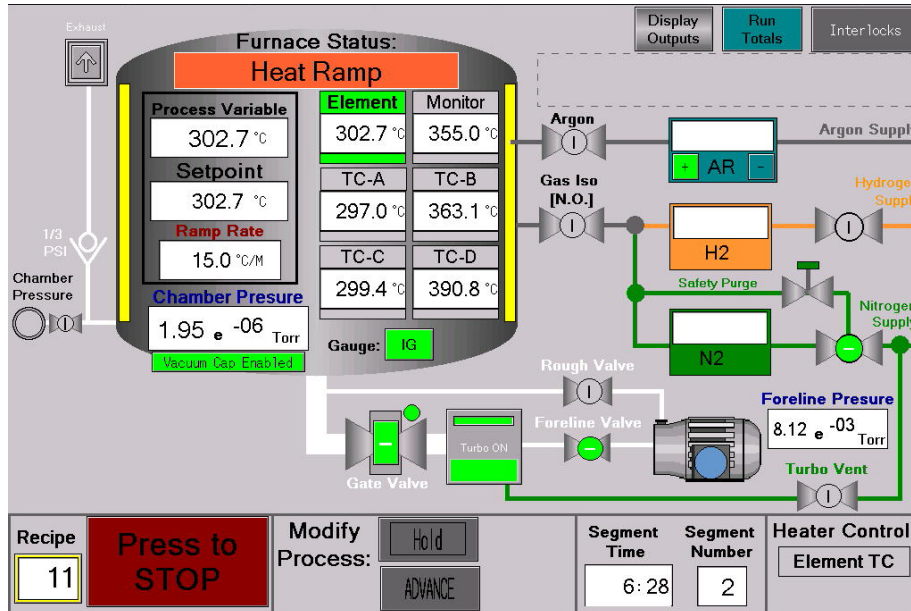

Easy Recipe Creating

Create segment-based recipes using a temperature setpoint and then input either time or ramp rate. All relevant events and inputs are displayed on one page to easily see at a glance what the entire profile will do. Events that are not relevant to the recipe runtime are hidden to remove screen clutter and prevent invalid recipes from being created.

Furnace View	Operator	Segment View	Recipe Edit	Historical Data	Control Panel	Event Logger	Screen Shot												
Recipe List	Recipe Chart	Enter Recipe Name: 1 1000° EXAMPLE H2		Select Runtype: Dry Hydrogen															
Segment	1	2	3	4	5	6	7	8	9	10	11	12	13	14	15	16	17	18	19
Heater Setpoint °C	10	300	300	700	700	1000	1000	0	0	0	0	0	0	0	0	0	0	0	0
Time [Min]	12	19	10	26	10	20	10	33	15	0	0	0	0	0	0	0	0	0	0
Heat Ramp [°/M]	15		15		15		-30												
Process H2 Flow 0-50 L/M	5.0	5.0	6.0	6.0	7.0	7.0	5.0												
Process N2 Flow 0-50 L/M	5.0	5.0						10.0											
Process Argon Flow 20.0 L/M																			
Auto Cooldown Process Control	Options	OFF	OFF	OFF	OFF	OFF	ON	OFF	OFF	OFF	OFF	OFF	OFF	OFF	OFF	OFF	OFF	OFF	OFF
	Options	Default	Default	Default	Default	Default	Default	Default	Default	Default	Default	Default	Default	Default	Default	Default	Default	Default	Default
Total Runtime:	2hrs. 18 Min.		Recipe Not Loaded!		INS Segment	COPY Recipe	Save												
			Load to Run		DEL Segment	Clear Recipe													

Helpful tools for Operators and Process Engineers

Users are presented with a Recipe Confirmation page before the furnace can be run to help prevent incorrect profiles from being used. Batch numbers are required for data logging but can be easily integrated into any existing downstream processing. Current and last run totals are kept track of for quick summaries including some of the most relevant data points.

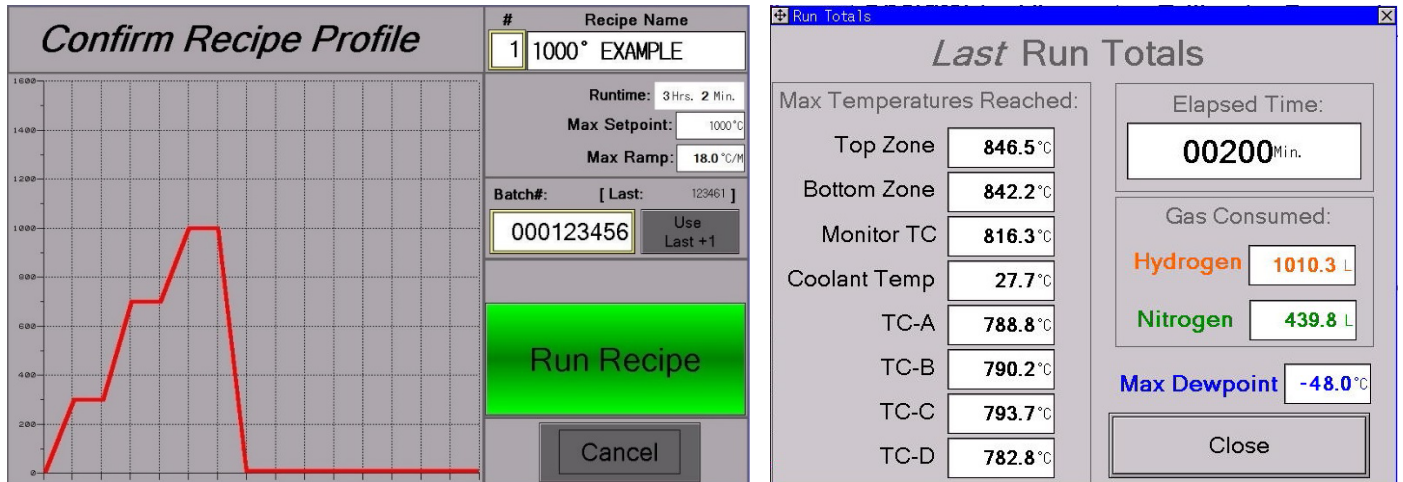

Multiple options for setting special control action to the heating loop - Cascade controls and guaranteed soak using different methods of workload calculation for highly customizable recipes. An easy-to-use software-enabled work limit prevents parts from melting or reaching otherwise problematic temperatures.

Built-in preventative maintenance tracker simplifies monitoring commonly serviced items, their intervals, and current conditions.



Many other helpful graphical popups and operator pages have been created specifically for Camco equipment. Please inquire if you are interested in a remote tech demo or more information on the software.

REV.	DATE	DESCRIPTION
A	7-7-04	ADD PART NUMBERS
B	6-10-09	ADD SHIELD #8, SHORTEN #5,#7 AT TOP
C	10-27-09	CHANGE PN FOR SHLD SUPPORT PIN

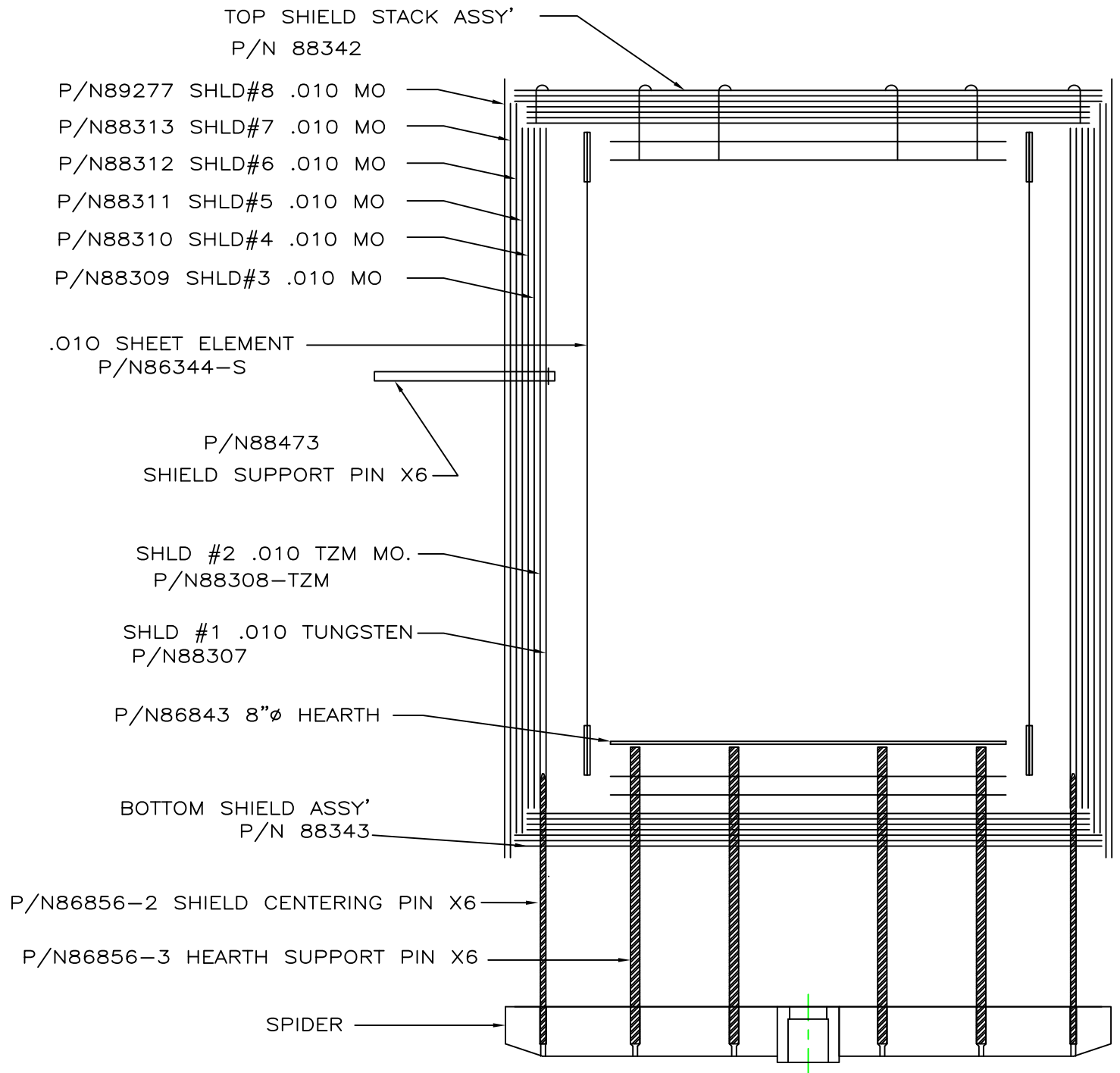

NOTICE: This document contains information which may be confidential and/or tradeseecret and/or proprietary to Concepts & Methods Co. Inc. and its' affiliates. This document is submitted to you in confidence and shall not be reproduced, disclosed to others, or used in manufacture without the express written permission of Concepts & Methods Co. Inc.

		TOL'S EXCPT AS NOTED	DRN.BY: T. BARULICH	 Concepts & Methods Company, Inc.
		fract. ±1/32	APP.BY:	
2000 DEG FURNACE		.XX ±.010	DATE: 03/02/01	TITLE: B-20 HOTZONE LAYOUT WITH P/Ns
B-20		.XXX ±.005	MAT:	DWG.NO: 88570
USED ON TASK	FWO	.XXXX ±.0005	FINISH:	SHEET 2 OF 3
		ANGLES ±1/2°		REV: B

B-2000 Hot Zone 8"Ø (200mm) X 12" (300mm) Depth
Tungsten and Molybdenum Heat Shields. Tungsten Bottom (Hearth) Plate

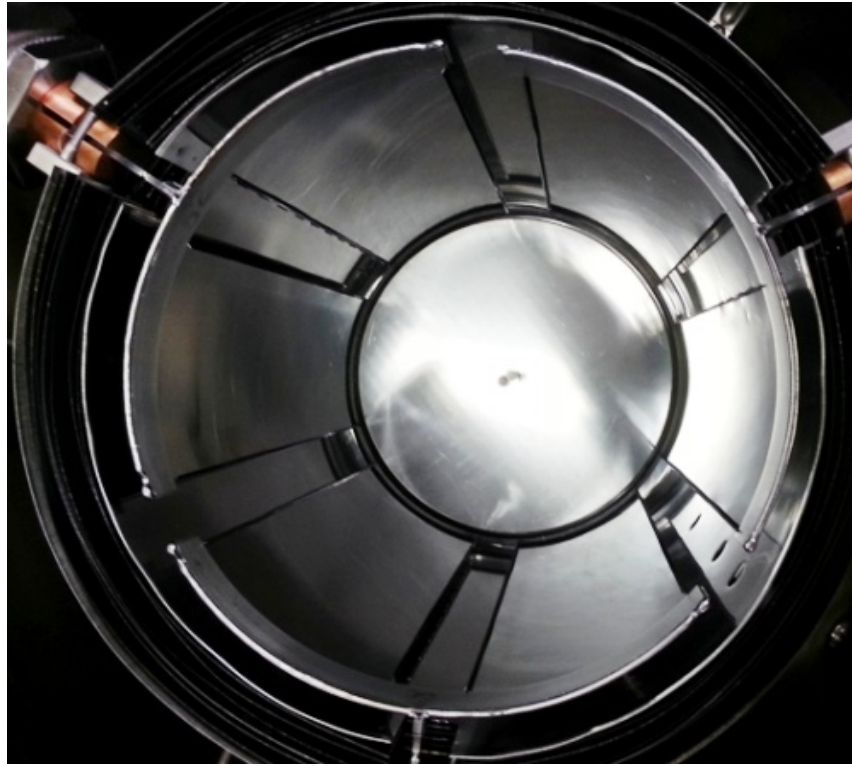

Standard Tungsten Sheet Element

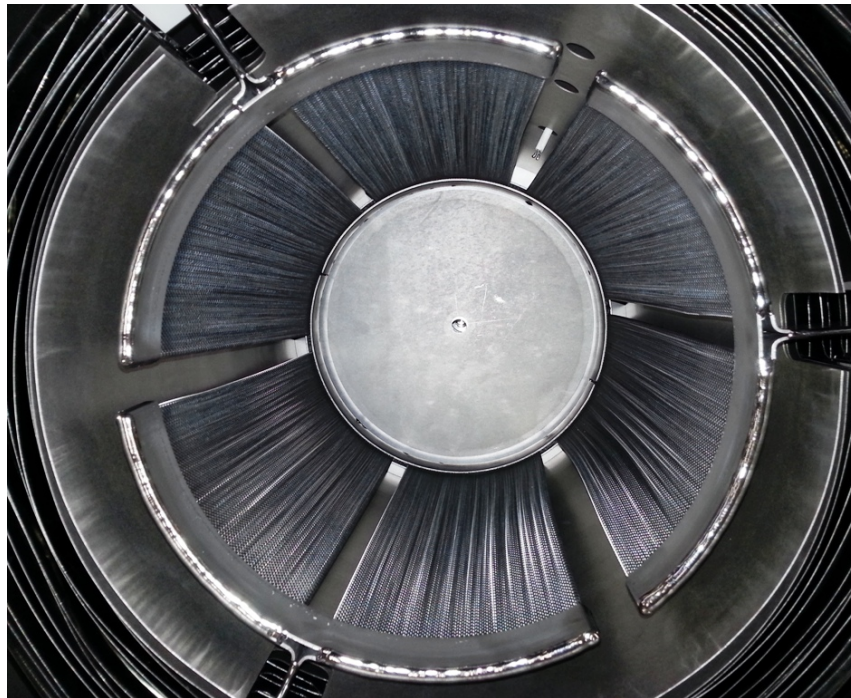

Optional Tungsten Mesh Element, for 2100° C Operation (Identical Dimensions)

REV.	DATE	DESCRIPTION
A	12-18-13	ADD HELIUM / ARGON LINE
B	2/17/22	UPDATE CTL CAB, UTILITY NOTES

- A: 150 A/LEG 208V. 120@240V. OR 60@480V. 60Hz 3 PH DISCONNECT.
- B: NITROGEN, 25 TO 30 PSIG AT A MAXIMUM FLOW OF 40 SCFH. 1/4" FPT
- C: ARGON OR HELIUM, 25 TO 30 PSIG FOR MAX FLOW OF 40 SCFH. 1/4" FPT
- D: COMP. AIR FOR VAC VALVES: 80-100 PSI 2 CFM MAX. 1/4" FPT
- E: COOLING WATER SUPPLY; 25 PSIG MIN AT A 5GPM 1/2" FPT
- F: COOLING WATER RETURN 15 PSI MAX 1/2" FPT
- G: LINE PRESSURE REGULATORS SET AT 40 PSI.

NOTE: (MAX. BACK PRESSURE 15 PSIG AT 5 G.P.M.)
 BTU OUTPUT AT MAX TEMP, 60,000 (5 TON)
 FOR CHILLER CALCULATION

ALL GAS AND AIR LINES AT BACK OF FURNACE
 ARE 1/4 SWAGELOK

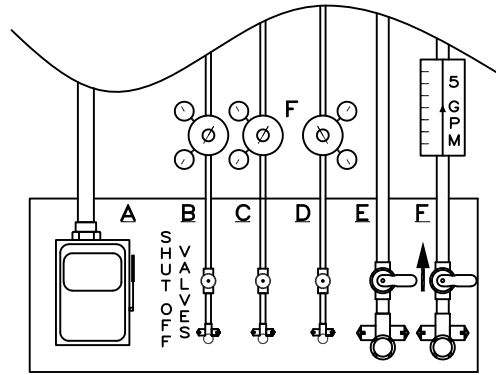

SUGGESTED UTILITY PANEL LAYOUT

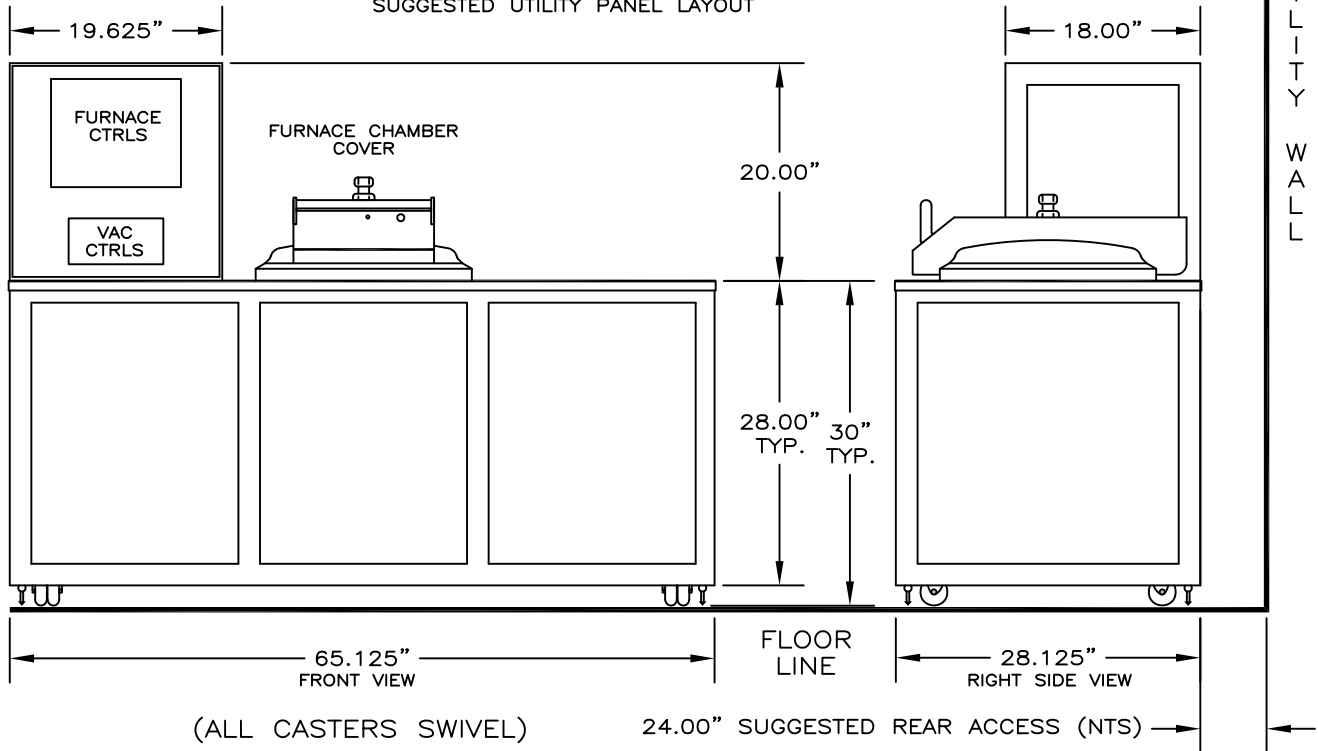

NOTICE: This document contains information which may be confidential and/or tradeseecret and/or proprietary to Concepts & Methods Co. Inc. and its' affiliates. This document is submitted to you in confidence and shall not be reproduced, disclosed to others, or used in manufacture without the express written permission of Concepts & Methods Co. Inc.

B-VAC FURNACE	FWO	TOL'S EXCPT AS NOTED	DRN.BY: ZEVADA 07/25/00	 Concepts & Methods Company, Inc.
		fract. ±1/32	APP.BY: T BARULICH 11-11-08	
USED ON TASK	FWO	.XX ±.010	DATE:	TITLE: B VAC INSTALLATION DWG.
		.XXX ±.005	MAT:	DWG.NO: 87698
		.XXXX ±.0005	FINISH:	SHEET 1 OF 2
		ANGLES ±1/2'		REV: B